

**BUBOX**<sup>®</sup>  
innovative floorbox

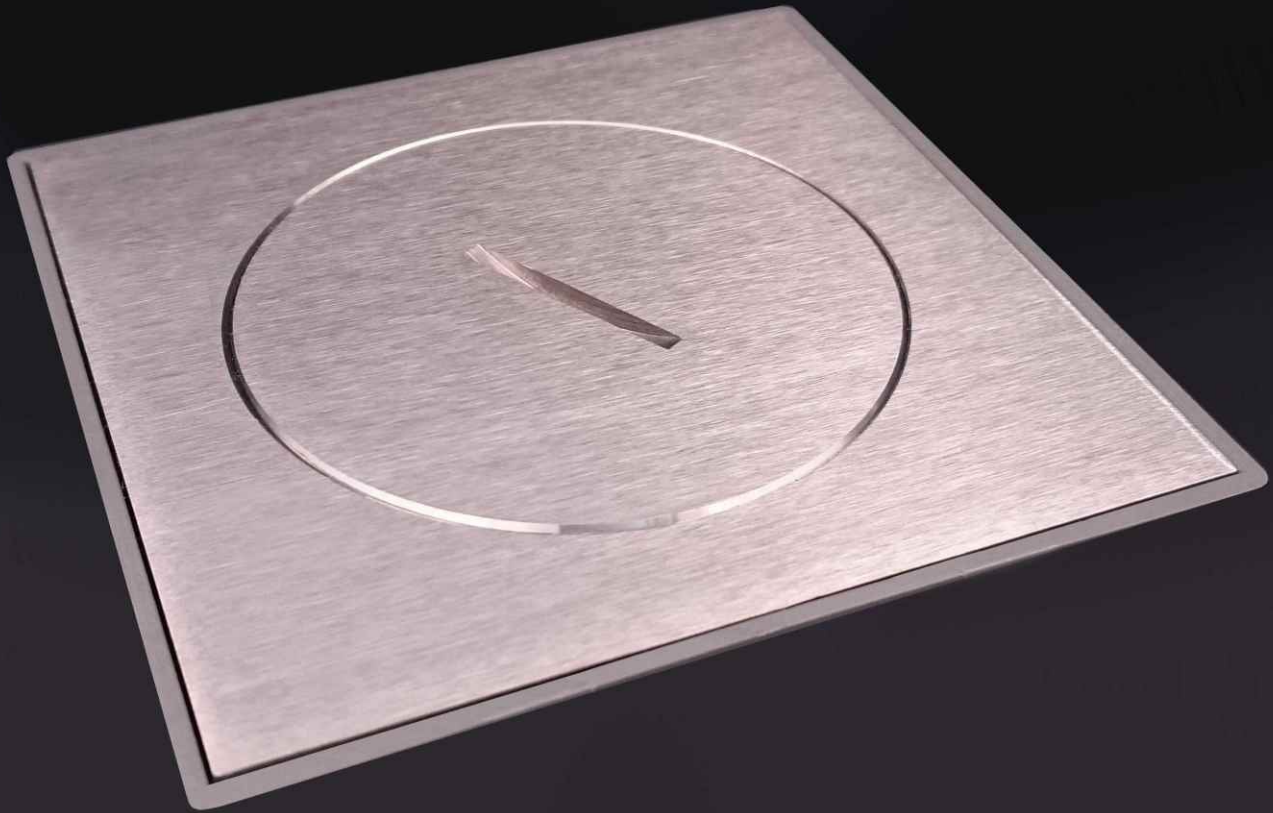

# Portfolio

Belgium | May 2017 | Version 1.0

architectural + design

The image shows a large, disorganized pile of green plastic components. These components appear to be parts from a mold, possibly for injection molding, and feature various shapes, including rectangular frames, curved sections, and small circular holes. The lighting is somewhat uneven, with some areas appearing brighter than others, highlighting the texture and form of the plastic. In the bottom right corner, the word "Content" is written in a bold, white, sans-serif font, standing out against the green background.

**Content**



**Housing**  
SS range

01



**Shopping center**  
Les Bastions

02



**Companies**  
Reception hall

03

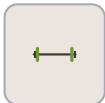

**Fitness center**  
Running belt

03



**Airport**  
Transit space

03



**Car showroom**  
Garage Verschaeren

04



**Bank**  
Bank vaults

05



**Museums**  
Brass range

05



**Health center**  
Kinesitherapist table

05



**Hotel**  
Reception

05 - 06



**Restaurant**  
Indirect lighting

06



**Terrace**  
Wood | Concrete

06



**Installation**  
Characteristic

07



**Protection**  
Plug protection

08



**Mechanism**  
B45 range

09



**Reference**  
Last references

10



Residential

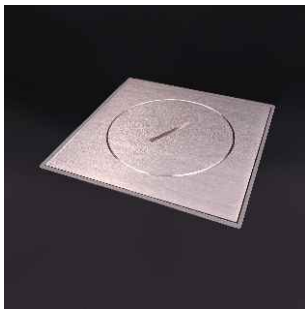

Closed | IP67

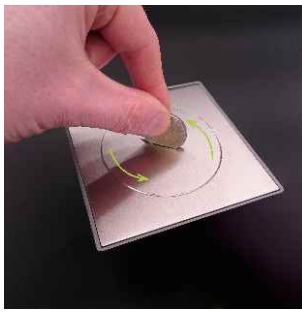

Open | IP20



# 01

Suits for :

Hall  
Living room  
Kitchen  
Bedroom  
Office  
Laundry  
Garage  
Wine cellar  
Terrace



**BUBOX**<sup>®</sup>  
innovative floorbox

# LES BASTIONS | SHOPPING CENTER



**Location :** 7500 Tournai, Belgium

**Project owner :** Wereldhave S.A.

**Architect :** H&V + Assar + dcDunnettCraven

**Stability :** TPF

**Special technics :** TPF

**Program :**

Restructuring and shopping center extension

**Area :** 50 000 m<sup>2</sup>

**Budget :** 50 000 000 € HTVA

**Status :** Under construction

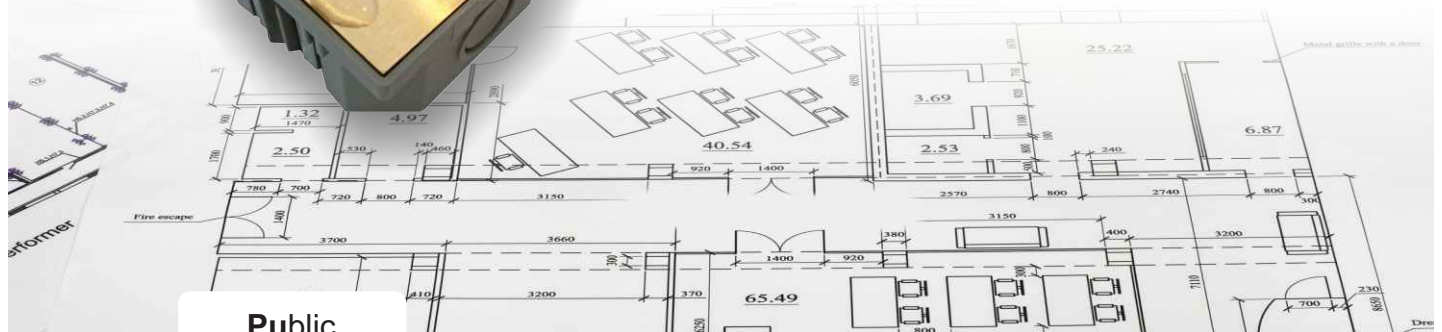
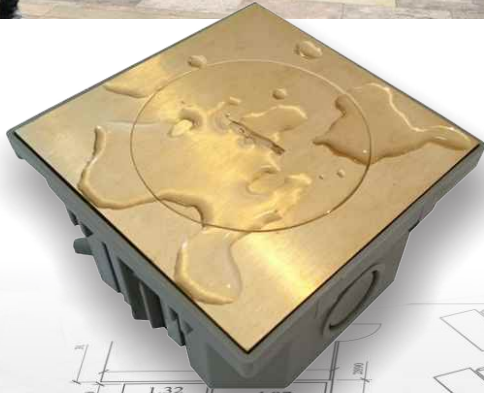

**Public**

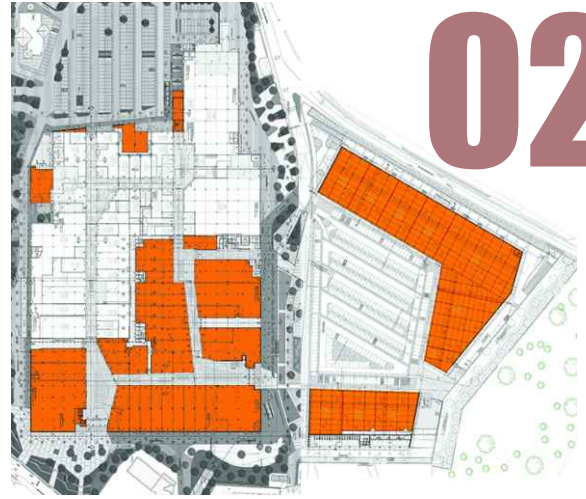
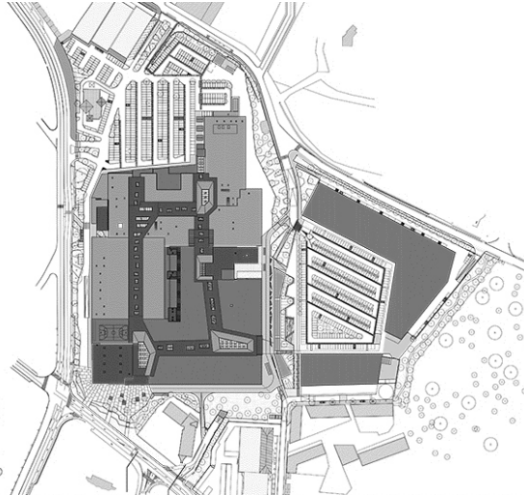

02

IP67

BUBOX Elite B10  
higher protection classes  
for higher requirement

IK10

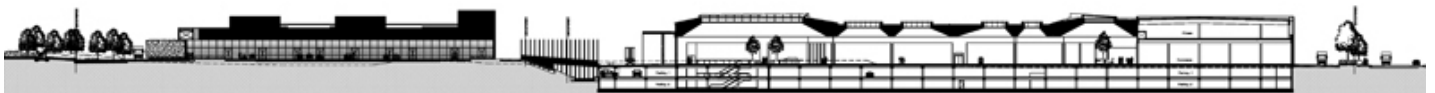
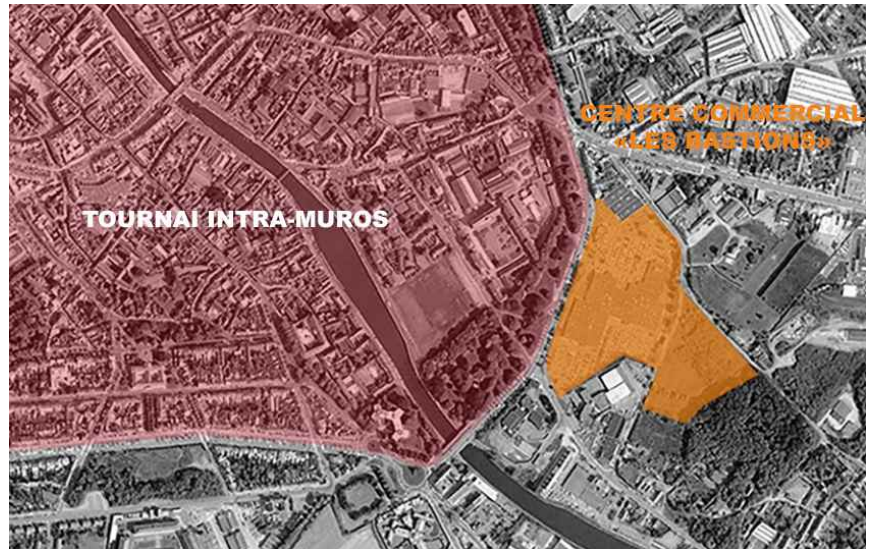



Tertiary





Company



Fitness room



Airport



Shop

# 03

Suits for :

- Company
- Shop
- Hypermarket
- Showroom
- Counter
- Showcase
- Self service store
- Light sign
- Zone of storage
- Secure acces
- Refrigerated room
- Train station
- Airport
- Fitness room
- Casino
- etc.



**BUBOX**<sup>®</sup>  
innovative floorbox



Tertiary



## VERSCHAEREN CAR SHOWROOM

# 04

**Location :**  
2200 Heist-op-den-Berg  
Belgium

**Project owner :**  
Garage GROEP LAC  
Verschaeren

**Program :**  
Show-room extension

**Quantity :** 120 pieces

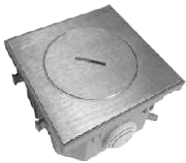

Higher crush strenght

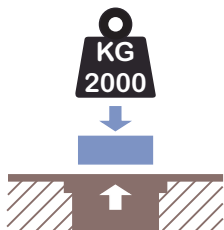

**BUBOX**<sup>®</sup>  
innovative floorbox



Residential | Tertiary



Health center



Museum



Bank



Hotel

# 05

Suits for :

**Health center :**

- Kinesiotherapist table
- Dental surgery
- Clean room

**Museum :**

- Window
- Kiosk
- Store

**Bank**

- Reception hall
- Office
- Bank vaults

**Hotel :**

- Reception hall
- Salon
- Room
- Meeting room
- Restaurant
- Laundry
- Kitchen
- Wine cellar
- Terrace



**BUBOX**<sup>®</sup>  
innovative floorbox

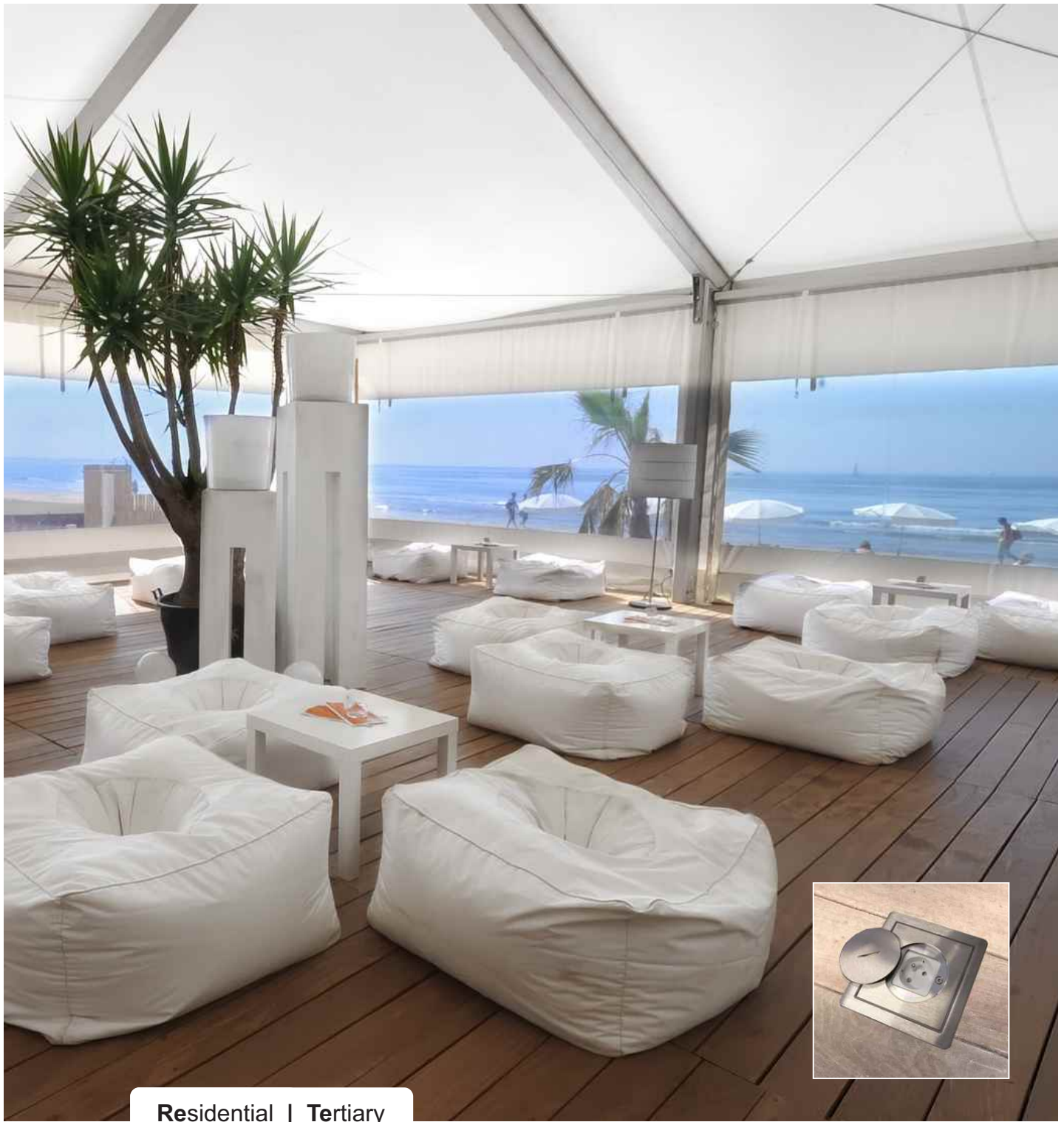

**Residential | Tertiary**



Hotel



Restaurant



Terrace | Stone



Terrace | Wood

# 06

Suits for :

**Terrace :**

- Indirect lighting
- Electric barbecue
- Electrical heating
- Receiving table
- Dish warmer
- Theater
- Music devices
- Loudspeaker
- Concert hall
- Buffet
- Exhibition hall
- Relaxation center
- Charger
- Multimedia contents
- HP cleaner
- Etc.



**BUBOX**<sup>®</sup>  
innovative floorbox



Installation



# installation in concrete screed

# 07

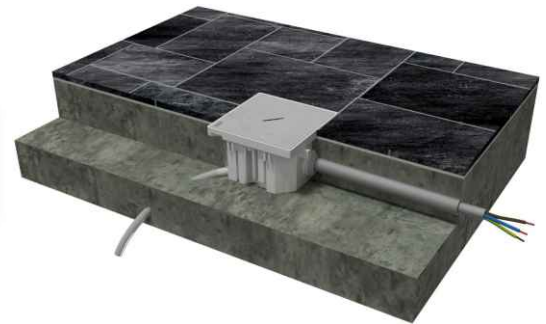
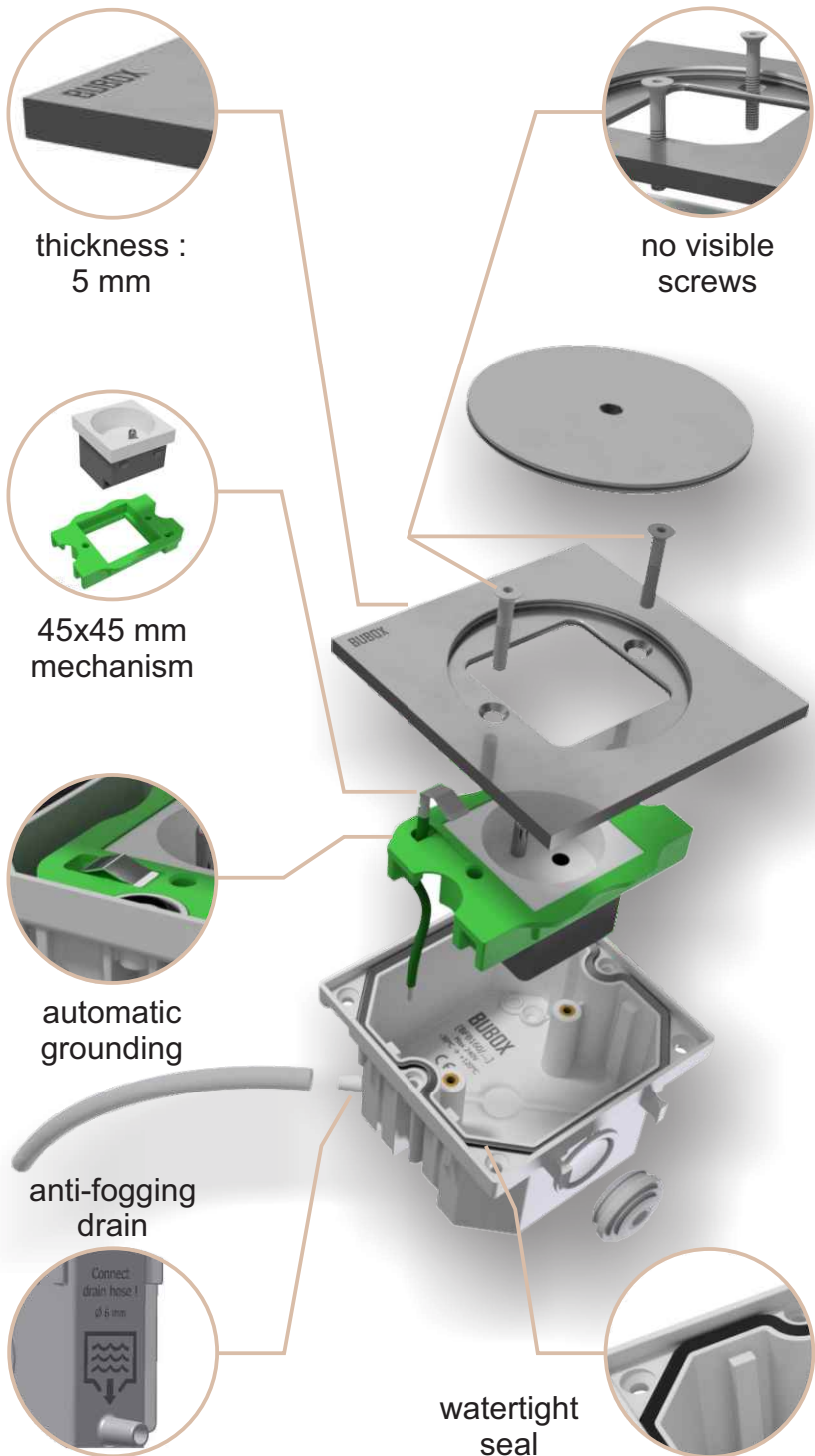



Installation

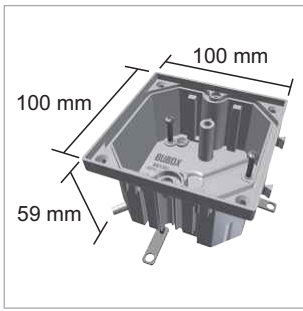

Dimensions

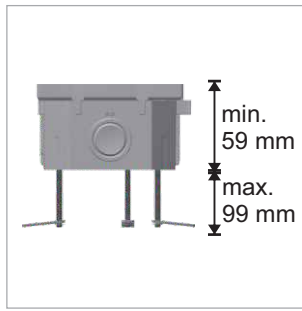

Height adjustable



Safety-lock opening



Standard opening

07





**Protection**



# 08

Protects the connected plug

Protection against splash guards

Watertightness guaranteed up to 4,5 cm high



**BUBOX**  
innovative floorbox

# Example of configuration

Mounting box



Cover with mechanism

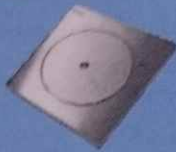

Watertight floor box



BFB160



BFC110/2



Watertight floor box (key-locked)

## MANUAL



-/1 brass

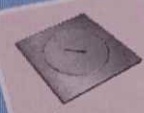

-/2 inox

## OPENING



-/1 brass

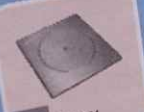

-/2 inox

## KEY-LOCKED

BFC100/- with an empty mechanism support for a 45x45 mm module

BFC101/- with a socket 16A 250V Schuko [DE]

BFC102/- with a socket 16A 250V NF/Cepec [FR]

BFC103/- with a socket 15A 127V Nema [US]

BFC104/- with a socket 13A 250V BS1363A [UK]

BFC105/- with a socket 13A 250V Afsnit [DK]

BFC106/- with a socket 10A 250V Sev-1011 [CH]

BFC107/- with a socket 10A 250V CEI16/VII [IT]

BFC108/- with a socket 16A 250V SI32 [IL]

## Accessories [Kit]

BFK107/- protection plug for indoor use

BFK108/2 stainless steel false floor kit

## MANUAL



-/1 brass

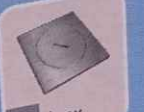

-/2 inox

BFC100/- with an empty mechanism support for a 45x45 mm module

BFC101/- with a socket 16A 250V Schuko [DE]

BFC102/- with a socket 16A 250V NF/Cepec [FR]

BFC103/- with a socket 15A 127V Nema [US]

BFC104/- with a socket 13A 250V BS1363A [UK]

BFC105/- with a socket 13A 250V Afsnit [DK]

BFC106/- with a socket 10A 250V Sev-1011 [CH]

BFC107/- with a socket 10A 250V CEI16/VII [IT]

BFC108/- with a socket 16A 250V SI32 [IL]

## Accessories [Kit]

BFK107/- protection plug for indoor use

BFK108/2 stainless steel false floor kit

The **B45** range is the perfect combination with **Elite B10 Classic**

# 09

Functioning :

**B45** range is installed by simple clipping in the mechanism-holder **BFC100/-** of the floorbox **Elite B10**

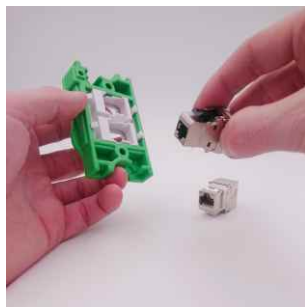

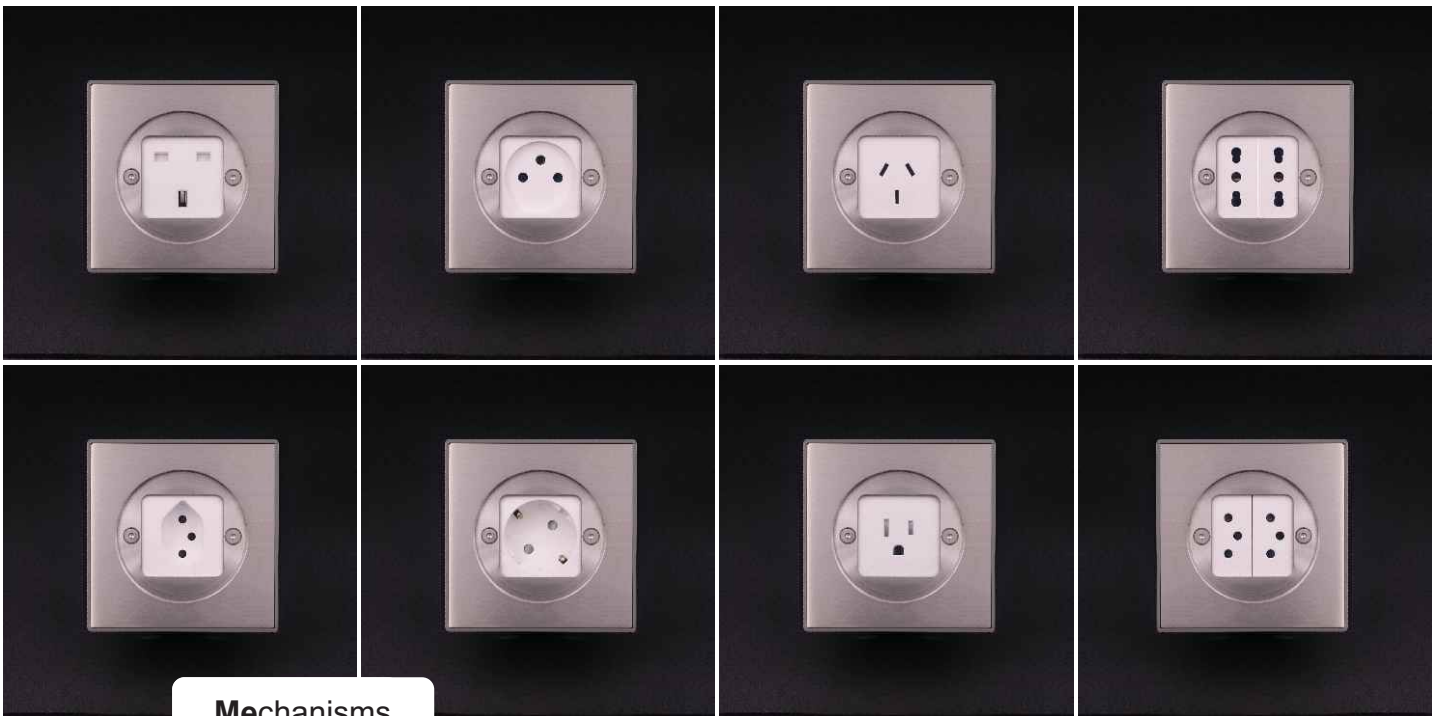
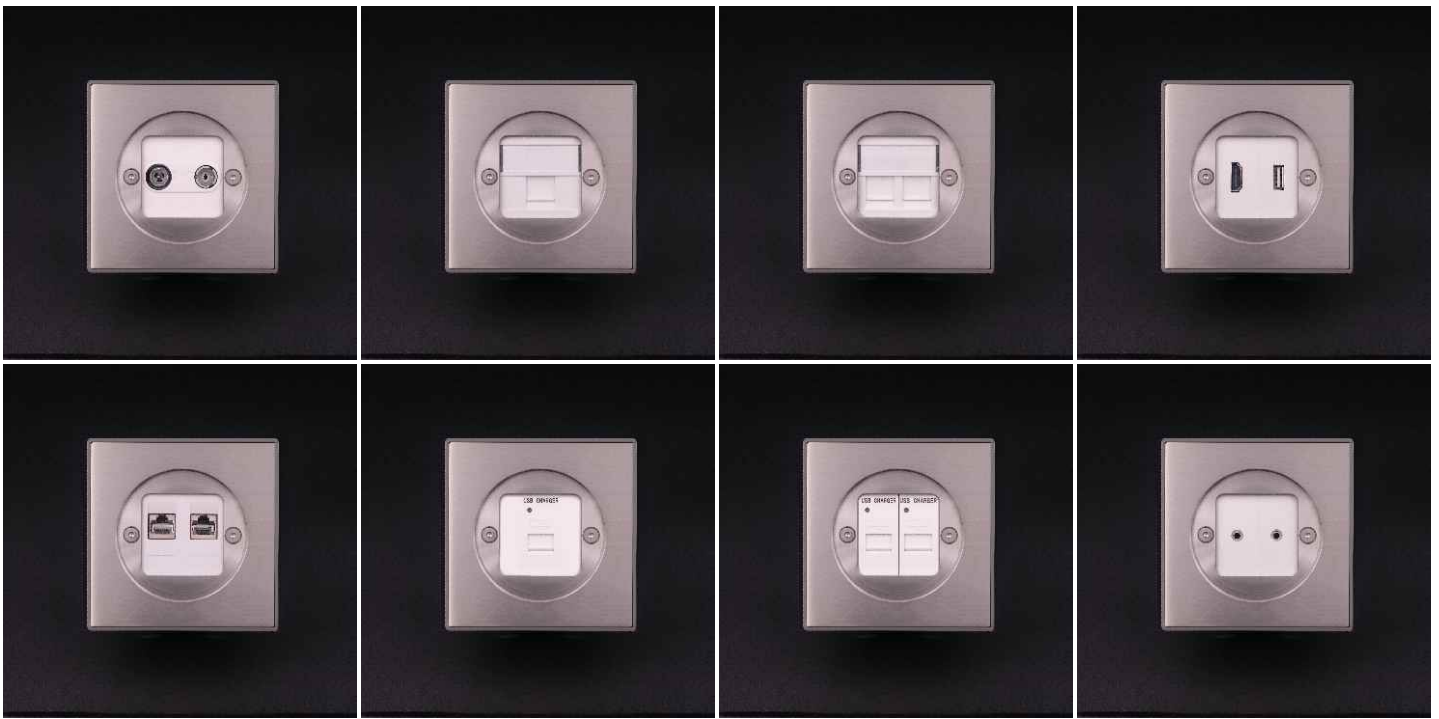

**Mechanisms**



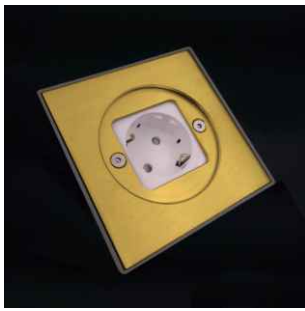

09



**BUBOX**<sup>®</sup>  
innovative floorbox

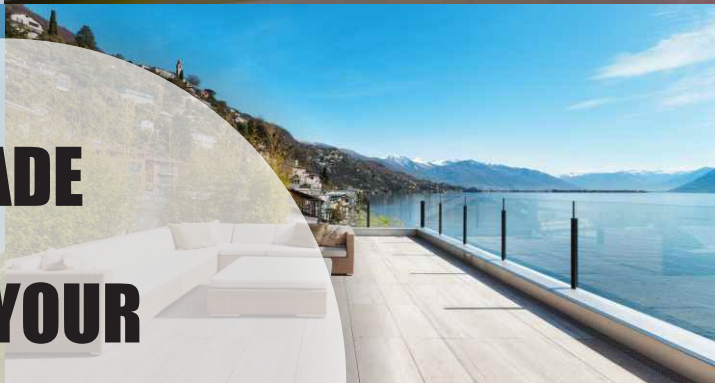
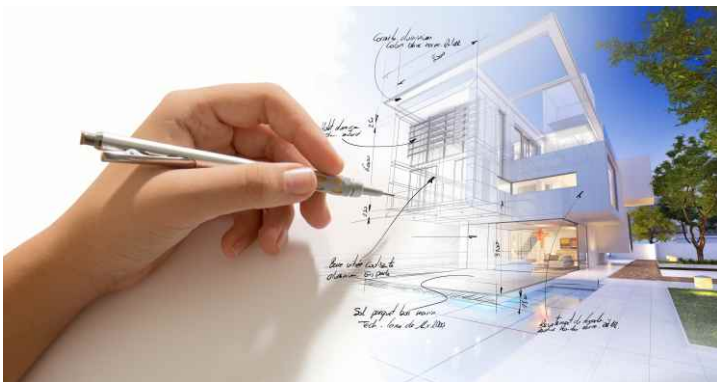

**MADE  
FOR YOUR  
INSIDE OR OUTSIDE  
NEW PROJECT**

## LAST REFERENCES



Disney Land Paris  
Marne la Vallée  
France



CHU  
Nantes  
France



Wiezmann Institute  
Rehovot  
Israel



Heathrow Airport  
London  
United Kingdom



Hotel de la Cry  
Mégève  
France

# THINK ABOUT

**BUBOX**<sup>®</sup>  
innovative floorbox

10



**BUBOX**<sup>®</sup>  
innovative floorbox

Bubox Systems Sprl  
Rue de l'Expansion, 33  
B-4460 Z.I. Grâce-Hollogne  
BELGIQUE

Tel +32 (0) 4247 6400  
Fax +32 (0) 4247 6409

info@bubox.eu

www.bubox.eu



[www.bubox.eu](http://www.bubox.eu)

MADE IN BELGIUM